



UNIT INJECTOR SPARE PARTS

EUI – PDE



OTO PERK A.S.

Sair Esref Bulvarı No: 27/2 35210 Izmir – TURKIYE

Tel : +90.232.4782990 Fax : 232.4783010

E-Mail : otoperk@eurodiesel.com Web : www.eurodiesel.com



+90.535 452 7030

Unit Injector (EUI-PDE-UIS) Repair Kits
VOLVO 2 Pin – 4 Pin Injectors

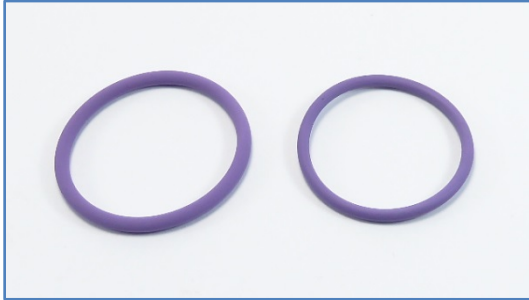

A1-23162 Repair Kit Volvo EUI

Use = Volvo 2 pin – 4 Pin Delphi Injectors

OEM = 7200-0016 + 7200-0017

OEM = F 00V X99 992 (Bosch 0 414 702***)



A1-23144 Repair Kit Volvo EUI

Use = Volvo Delphi EUI / Yellow side Actuator

7200-0016 + 7200-0017 + 7200-0014 + 7200-0015

OEM = Volvo 276948



PRK135-486 Valve Kit Actuator Delphi EUI

Use = Volvo FH Actuator

OEM = 7135-486 (Valve Used Inside)



PRK206-0379A

Actuator Volvo 2 Pin Injectors
Without Electrical Coil



PRK206-0379

Actuator Volvo 2 Pin Injectors
With Electrical Coil

Unit Injector (EUI-PDE-UIS) Repair Kits
VOLVO 2 Pin – 4 Pin Injectors



P2-03059 Inj. Sapcer Kit Type Delphi EUI

Use = Volvo FH
Using Actuator 7135-486

OEM = **7135-487**



P2-02039 Inj. Pressure Spring EUI

Use = Volvo / Delphi 4 pin Injectors

OEM = **7207-0070**

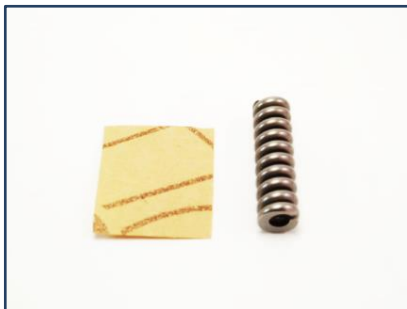

P2-02032 Inj. Pressure Spring EUI

Use = Volvo / Delphi 2 pin Injectors

OEM = **7169-539**



A2-23294 Repair Kit Volvo FH

Use = Volvo FH

OEM = **7135-488**



A2-23476 Repair Kit Volvo FH

Use = Volvo FH Actuator

OEM = **7135-476**

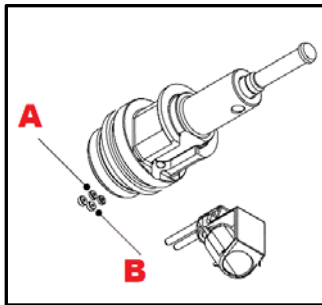

A4-15579 Backing O'Ring
Use = Volvo **2 Pin – 4 Pin** Injectors

Oem No : 7204 -0375

Figure : " A "



ED4069 Electrical Connector
Use = Volvo **4 Pin** Injectors

Including 20 cm Cable (mounted)



ED4070 Electrical Connector
Use = Volvo **2 Pin** Injectors

Including 20 cm Cable (mounted)



PRK135-588 Actuator Complete

Oem No : 7135-588

Use = Volvo **4 Pin** Injectors



A4-15299 O'Ring Set

Oem No : 7200-0031

Use = Volvo **2 Pin** Injectors

John Deere Unit Injector BEBE4B13001

Unit Injector (EUI-PDE-UIS) Repair Kits
DAF Euro5 - Smart



A1-23717 Repair Kit DAF Euro 5

Use = Injector Daf Euro 5 Delphi Unit Pump

OEM Ref's Included = 7207-0100 / 7200-0027

7200-0070 / 7200-0071 / 7208-0247



A1-23716 Repair Kit DAF Smart Euro 5

Use = Injector Daf Euro 5 Delphi Smart Injector

OEM Ref's Included = 7200-0118 / 7200-0119

Injectors's Used :

BEBJ1A00001 / BEBJ1A00101

BEBJ1A00201 / BEBJ1A00202

BEBJ1B00001

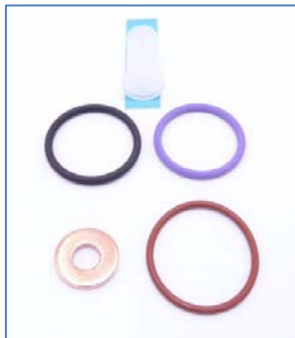

A1-23716S Repair Kit DAF Smart Euro5
Euro6

Use = Injector Daf Euro 5 Delphi Smart Injector

OEM O'ring Ref's Included :

7200-0118 + 7200-0119 + 7200-0271

Injectors Used : BEBJ1A00001 / BEBJ1A00101

BEBJ1A00201 / BEBJ1A00202

BEBJ1B00001

BEBJ1A05001 / BEBJ1A05002



A1-23716A Repair Kit DAF Smart Euro6

Use = Injector Daf Euro 6 Delphi Smart Injector

OEM Ref's Included = 7200-0119 / 7200-0271

Injectors's Used :

BEBJ1A05002

BEBJ1A05001



PRK206-0460 Actuator Valf Daf Euro5

Use = DAF Euro5 Smart Injectors

Oem : 7206-0460

Unit Injector (EUI-PDE-UIS) Repair Kits
Type Bosch



A1-23367 Valve

Unit injector Valve

Dia's . 6.995 to 7.040 mm



A1-23203 Repair Kit EUI Iveco

Use = Iveco Stralis, Eurotracker, Eurotech

Unit Inj. Ref's = 0 414 700 002/ 003

OEM = **F 00V X99 996** Iveco ref : 500350189



A1-23206 Repair Kit EUI Scania

Use = Scania 1398810 - 1422564

Unit Inj. Ref's = 0 414 701 005 / 007 / 008

OEM = **F 00V X99 999**



A1-23202 Repair Kit EUI Scania

Use = Scania 1440576 – New Holland 500379769

Unit Inj. Ref's = 0 414 701 006 / 013

OEM = **F 00V X99 995**

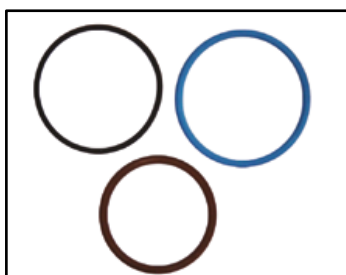

A1-23718 Repair Kit EUI Scania

Use = IVECO Cursor

0 414 703 004 – 0 414 703 008

OEM = **F 00H 4S0 011**

Unit Injector (EUI-PDE-UIS) Repair Kits Type Bosch



A1-23205 Repair Kit EUI Scania

Use = Scania 1731209

OEM = **F 00H N37 928**



A1-23471 Repair Kit Scania G Series

Use = Scania G series trucks

OEM = **F 00H N37 927 + 928 + F 00V X99 999**



A1-23210 Repair Kit Scania EUI

Use = Injector Bosch 0 414 701***

OEM = **F 00H N37 926 + N37 927 + F 00V X99 999**



A2-23282 Repair Kit Volvo FH

Use = Volvo FH Body
0 414 701 004 / 0 414 701 055
0 414 702 002 / 0 414 702 017

OEM = **F 00V X99 998**

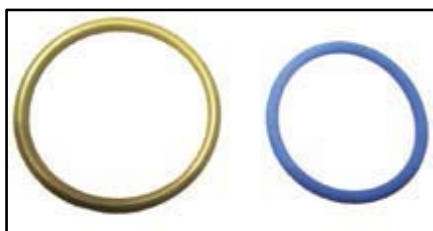

A2-23432 Repair Kit Volvo FH
Scania Body 154072 -1766553
Use : 0 414 701 037 ***

OEM = **F 00H 450 002**

Unit Injector (EUI-PDE-UIS) Repair Kits
Type Bosch



A2-23431 Repair Kit EUI

Use = Iveco Stralis Euro 5 = 0 414 703 008 - 009
Iveco EuroTracker = 0 414 703 004

OEM = **F 00H 450 001**



A2-24032 Repair Kit EUI

Use = Iveco Stralis 430-480-530 = 0 414 701 013
Iveco EuroCargo 280-330-350-400 = 0414701 006

OEM = F 00H N37 928 + F 00V X99 998



A2-23217 Repair Kit EUI / Universal

Use = Volvo B12 – FH 12
Use = Iveco Stralis, EuroCargo / Scania

OEM = F 00H N37 928 + F 00V X99 998 +
F 00V X99 996
REF Volvo : 276948



A2-23213 Repair Kit EUI / Universal

Use = Iveco Stralis, EuroCargo , EuroTech

OEM = F 00H N37 928 + F 00V X99 996

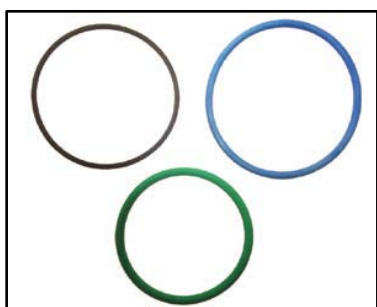

A2-23642 Repair Kit EUI

PDE 100S4001/2/4/6

Use = 0 414 703 ***
002/003/005/007

Unit Injector (EUI-PDE-UIS) Repair Kits
Type Bosch



A1-23218 Spring & Pin Kit
Bosch PDE 90 / 100

Oem No : F 00H N37 926



A1-23433 Spring & Pin Kit
Bosch PDE 100

Use = 0414703***

Oem No : F 00H 4S0 008



P2-03046 Inj. Intermediate Plate EUI

Use = Scania / 1774409
0 414 700 002 ... / 0 414 701 004

OEM = F 018 B06 804 / F 00Z Z20 003

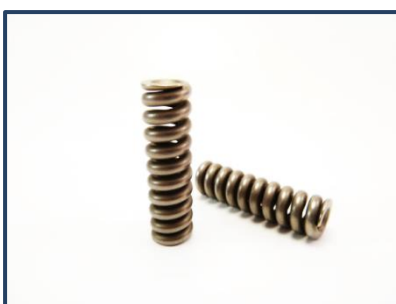

P2-02027 Inj. Pressure Spring Bosch EUI

Use = Iveco / 0 414 700 008 & Similar Injectors

OEM = 2 434 614 040



P2-23028/1 Injector Spacer PDE90 / 100

Use = 0414701** / 702** / 703 ***

Oem No's : F 00Z 220 003
F 00H N35 703

Dia : 17.8 x 7 mm

Unit Injector (EUI-PDE-UIS) Repair Kits
Type Bosch



PRKIVE-002 Piston Valve IVECO

Suitable For 0 414 703 003 / 0 414 703 008

Various Sizes : 4.000 mm / 4.002mm
4.004mm / 4.005m



A1-23420 Piston & Sphere Set

Use : 0414701*** Bosch Injectors

Oem No : F 00V X99 886

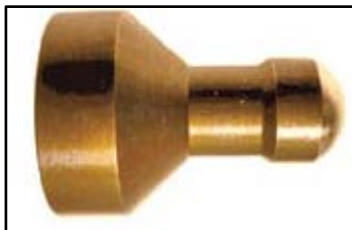

A1-23419 Piston

Use : IVECO Stralis - Trakker

Oem No : F 00H N36 046



A1-23422 Piston & Sphere

Use : 0414701005 /***

Oem No : F 00V X99 994



A1-23421 Piston & Sphere

Volvo

Use : 0414702*** / Bosch Unit Injectors

Oem No : F 00V X99 887

Unit Injector (EUI-PDE-UIS) Repair Kits
Type Bosch



A1-23391 Plug PDE 90 / 100

Thickness : 14,56 – 15,10 mm
Available as sets with various Dia's



A1-23430 Reamer for Valve Seat

Unit pump valve seat reamer
With hand Use
Longlife durable material

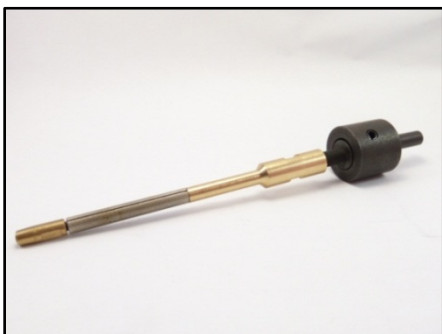

A1-23365 Reamer for Valve Hole

Unit pump valve holereamer
With drill use
Longlife durable material



A1-23425 Plate

Various sizes
3.80 mm to 4.00 mm
+02 mm increase